

AN ANALYSIS ON IN PLANE LOADING SHEAR WALL EARTH BLOCK BY USING ETABS

M. Praveen kumar

M.Tech (Structural
Engineering)
St Martins Engineering
College, Dulapally,
Telangana
praveenmk2497@gmail

G S.Vignan

Assistant professor
St Martins Engineering
College, Dulapally,
Telangana
vignan2007@gmail.com

P.Guruswamy

Assistant professor
St Martins Engineering
College, Dulapally,
Telangana
guruswamygoud@gmail.
com

Y.Nagarjuna

Assistant professor
St Martins Engineering College,
Dulapally, Telangana
y.nagarjuna@yahoo.com

T.Saikrishnateja

Assistant professor
St Martins Engineering College,
Dulapally, Telangana
Krishna.tej919@gmail.com

Abstract

This thesis investigates the flexural behavior of interlocking compressed earth block (ICEB) shear walls. In-plane cyclic tests were conducted to evaluate the performance of three flexure dominant large scale ICEB specimens: a slim wall with a 2:1 height to width aspect ratio, a flanged wall, and a wall with an opening at the center. Following the experimental investigation, two types of analyses were conducted for calculating the ultimate strength of flexure dominant ICEB walls: a nonlinear static analysis model assuming lumped plasticity and a plastic analysis model. In addition, incremental dynamic analysis was conducted to address the seismic performance of flexure dominant ICEB buildings. Based on the database from the incremental dynamic analysis, the collapse potential of demonstration ICEB buildings were compared for the countries of interest.

Keywords: interlocking compressed earth block, flexural behavior, cyclic testing; Nonlinear analysis.

1.0 Introduction

Interlocking compressed earth block (ICEB) construction is a form of dry stack masonry construction used as a low cost building material. The manufacturing and construction process of ICEB buildings requires no special skills and can be performed by inexperienced labors making it an attractive building material for developing countries. Earth is one of the oldest building materials, and is still widely used around the world. It is estimated that more than 30 percent of the world's building materials are made of various forms of earth construction with the most common forms of earth construction being adobe, rammed earth and compressed earth masonry. Having gained popularity as an aesthetically pleasing, low cost, and sustainable building material, earth masonry construction is becoming more widely used as a form of housing around the world.

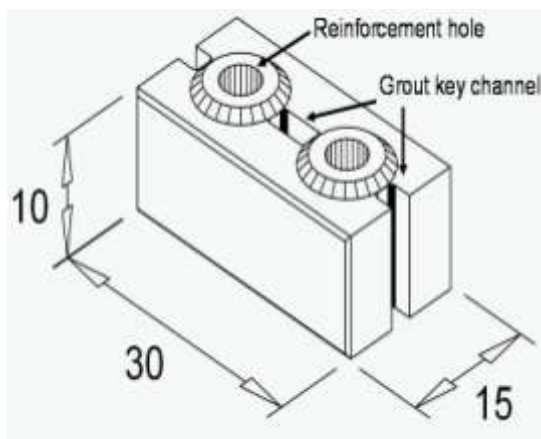

Figure 1-1: ICEB “Rhino” block



Figure: Sheng Thai BP6 Block press

This form of dry stack masonry has several advantages in building construction in developing countries. The interlocking dowels easily align adjacent blocks allowing relatively untrained labors to efficiently construct their own dwellings. Not requiring mortar saves construction time, labor and cement used in construction.

Objectives of study the objectives of the study are:

- An investigation of the mechanism of failure of IBS block work wall in laboratory and using software ETABS modeling to build a model to validate its mechanism of failure.
- To compare the results of modeling with actual laboratory test.

Scope of study

The scope of the study are to carry out an ETABS software analysis on IBS wall block work components and investigate the mechanism of failure due to applied external vertical loads. Stresses induced from early mentioned loads that will stream in components, resulting in crack and spalling of the whole system. The scope is to include the behavior and strength, deflection and pattern of failure of the models.

2.0 Literaturereview

Bales et al. (2009) conducted significant research with the “Rhino” interlocking compressed earth block, produced using the Soeng Thai BP6 press. For determination of an optimum earth block mix, they focused on the impacts of different soil types, cement content, and water content on ICEB durability, compressive strength, and compaction. ICEBs produced using a design mix formulated by the authors were tested to determine the associated block compressive strength, grouted and ungrouted prism strength, lateral shear strength, and pullout strength with both steel and bamboo reinforcement.

Bland (2011) experimentally addressed the shear behavior of ICEB walls as a companion effort of this thesis. Two fully grouted and one partially grouted 1.8 x 1.8 meter ICEB shear walls were tested using displacement controlled cyclic loading to determine the strengths and failure modes of the ICEB specimens. Material property testing was also conducted on ICEBs and grouted ICEB prisms for use in analytical work.

Perera and Jayasinghe (2003) conducted an experimental investigation to determine optimal cements contents used in cement stabilized earth construction of compressed earth blocks. This experiment

investigated both the prism strength of the fully grouted compressed earth block, with varying cement ratio from 2% -8% and soil fines content from 20%-45%, and the panel strength of compressed earth blocks with varying cement ratios.

3.0 Methodology:

This chapter briefly presents the material properties pertinent to the experimental and analytical work of this thesis, containing a brief discussion of compressed earth blocks and reinforcing steel rebar, strength of the masonry prism, and the idealized models of the masonry which are required in the numerical work presented

Interlocking Compressed Earth Block:

The interlocking Compressed Earth Blocks used in this thesis were constructed onsite at Cal Poly using a Soeng Thai Model BP6 press. The Soeng Thai Model BP6 press is capable of producing different types of block by adding or removing various inserts. The base block, shown in Figure 1-1, is a full block commonly called the “Rhino Block” used to interconnect any form of dry stack masonry construction. The “Rhino Block” is composed of two reinforcement holes used for vertical grouted reinforcement-- and three “grout key channels” commonly filled with a fluid grout to provide wall stability and load transfer. For the construction of the three wall specimens tested in this thesis, six different variations of the standard full block were used, shown in Figure 3-1.



a) Full Block b) Full Channel Block



c) Half Block d) Half Channel Block

The full fabrication process for constructing ICEBs using the Song Thai Model BP6 press is described in detail in the companion thesis (Bland, 2011). Each eight-block batch used a mixture comprised of soil, sand, cement, and water in the construction of each ICEB.

Masonry Prism Testing

The average compressive strength of the masonry (f'_m) of each specimen was tested with masonry prisms. Each prism was constructed from three fully grouted, vertically stacked ICEBs which were built at the same time and cured under the similar conditions as the wall specimens. The prisms were capped top and bottom with a hydro stone capping compound to form a flat surface and to ensure a uniform load distribution on the prism. Confinement was applied to each prism with plywood boards tightened against the end of the prism with three sets of two thread rods, hand tightened, to provide passive confinement. Each prism was loaded at a strain rate of 20 microstrains per seconds ($\mu\epsilon/s$), which corresponded to a displacement rate of approximately 0.4

millimeters per minute (mm/min) in order to achieve an accurate stress versus strain profile of the tested prisms. Each test was run for approximately 40 minutes allowing for a total 15.8 mm of compression on the prism. The strain was measured in two different ways, with extensometers fastened to the outside of the prism to directly measure the strain in the masonry and with LVDTs placed on either end in of the prism. Extensometers were used to measure the strain in the masonry until the prism began to crack and spall outwardly; the extensometers were then removed to prevent the instruments from damage.

Specimen design and construction

This chapter provides a detailed description of the design and construction process of the ICEB specimens. All specimens were reinforced with 10M steel rebar, longitudinally and transversely. Detailed information about the rebar arrangements can be found in the following sections; while grout and mortar proportions, used in specimen construction can be found in Appendix A. W4 is a 1.8 meter tall and 0.9 meter long wall with a 2:1 height-to-width aspect ratio designed to investigate the effect of aspect ratio on ICEB walls. To focus on the impact of wall aspect ratio on its seismic behavior, the only variable changed from W3 (tested in the companion thesis) to W4 was the aspect ratio, done by essentially building half of W3. The procedure presented in Section 4.2 outlines and explains the steps taken to build W4 and the rationale behind the manner in which the wall was constructed, while the overall

reinforcing pattern is shown in Figure 4-1.

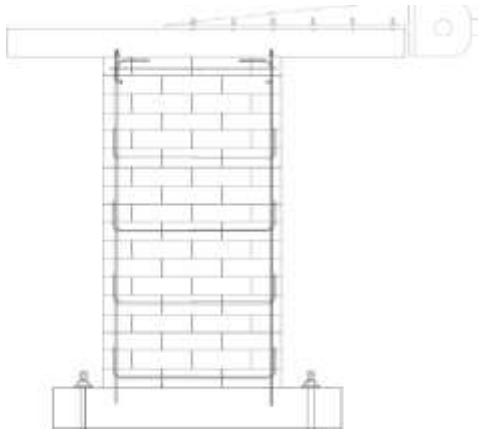

Figure: W4 reinforcing pattern

The T-wall (W5) was designed as an intersecting flanged wall with the web having a 1:1 aspect ratio and a 0.75 meter wide flange on one end of the wall. Testing W5 allows for a direct comparison between W3 and a flanged wall with the exact same reinforcing determining on the contribution of the flange to the walls strength, ductility, and overall performance.

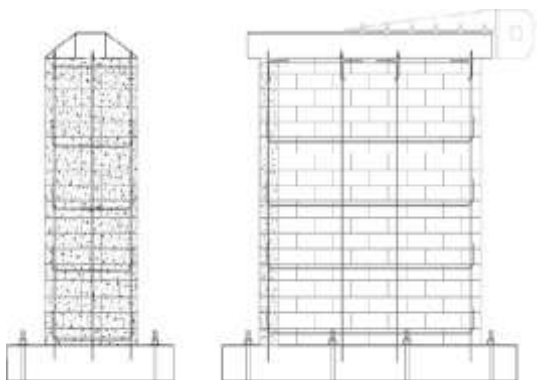

Figure: W5 reinforcing pattern

W6, a 1.8 m tall and 1.8 m wide wall with a 0.9 m x 0.9 m square window opening at its center, was designed to create a direct comparison between a solid wall and one with a opening. The rebar was set approximately 5mm above the channel and tied with steel wire to the vertical rebar. This prevented the rebar from resting on the bottom of the channel, and provided a stronger bond between the grout and rebar



Figure: Adapted cobra pattern for W5

The pattern in the fifth course of the flange was the same the first course, as the pattern repeats itself every five courses. The same is true with the horizontal reinforcing pattern of transverse rebar; however, in order to more evenly distribute the shear forces from the web into the flange, the transverse rebar coming into the web was hooked opposite to the reinforcement below it. Hooking the rebar on both sides of the flange helped balance the shear transferred into both sides of the flange in the push and pull cycles. After rebar had been inserted in both the web and the flange of the fifth course of the wall, it was necessary to make the wall both level and plumb.

Observations from the tests

This chapter presents in detail the observation from the testing of all the specimens described

Testing of W4

The slim wall (W4) was tested 25 days after construction. The testing consisted of thirty-one cycles of the prescribed loading protocol. The maximum force produced from W4 in the pull and push directions were 13.2 kN and 14.4 kN, respectively. The corresponding displacements were 16 and 20 mm in the pull and push directions, respectively. During testing, the force resisted by the

wall was recorded at the corresponding displacements; however, a significant amount of slip was detected between the footing and the strong floor, as shown in Figure 6-1. These slip values were subtracted from the displacements recorded at the top of the wall to give a more accurate force displacement relationship shown in Figure 6-2.

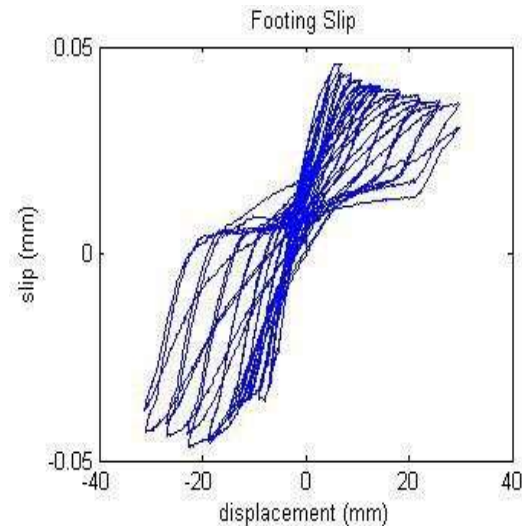

Figure: W4 footing slip vs. lateral displacement of actuator

The wall resisted 9% more force in the push direction than in the pull direction as described by the force and displacement relationship depicted in Figure 6-2. It is noted that there are many reasons which may have contribution to this observation (e.g. horizontal slip deformation at footing, initial imperfection of construction, non-uniform property of the construction materials; and possible premature failure at wall base resulting in slight uplift deformation of the wall at the tension side). However, to further quantify their impacts is beyond the scope of this thesis given that the resistance difference is within the acceptable range from the perspective of engineering design. The following sections describe in detail the observed behavior of W4 at different deformation levels.

Discussion of testing result

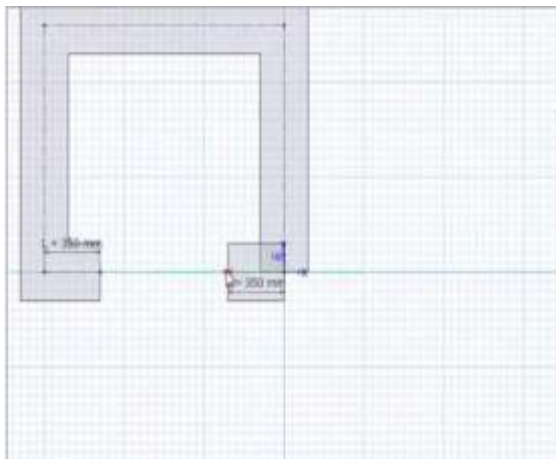

Figure: plane surface of shear general wall

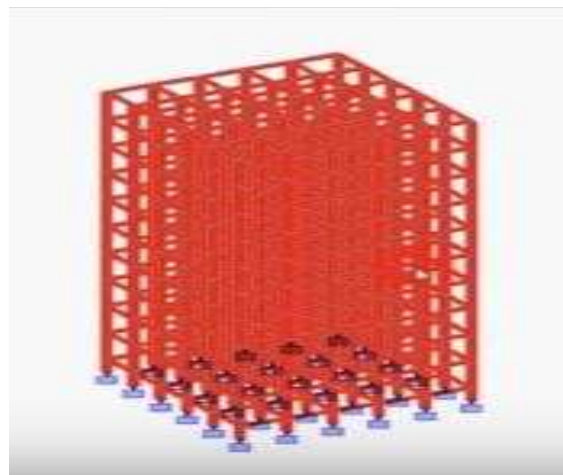

Figure: 3D view or base maximum ascending loads

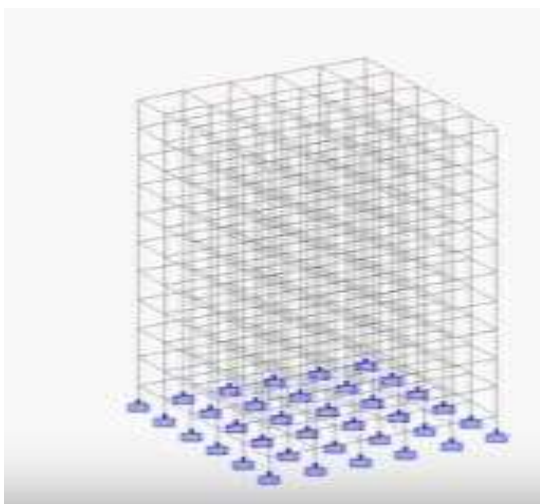

Figure: displacement of the 3D viewbase point

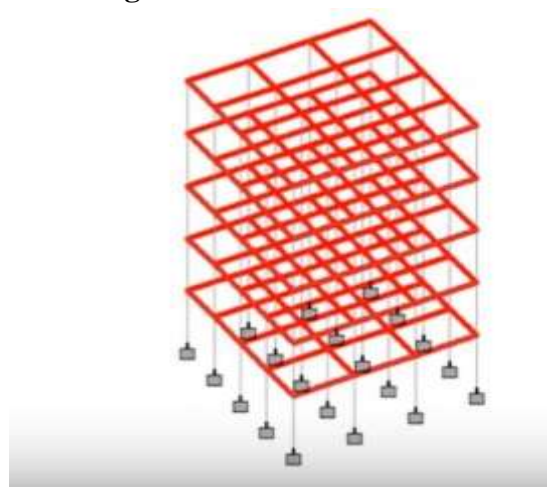

Figure:3D or ascending base loads of the surface

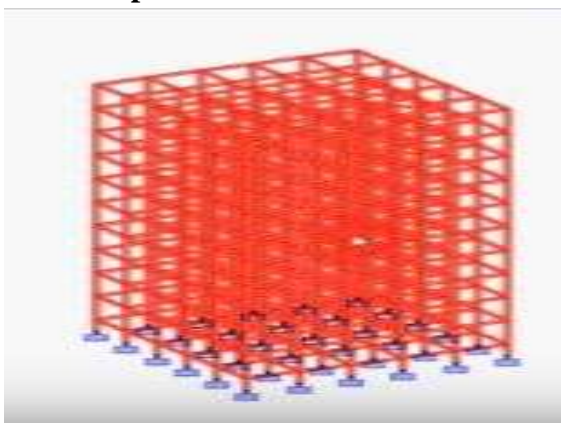

Figure: 3D view or base ascending loads

Conclusion:

This thesis conducted experimental and analytical investigations on flexural behavior of three commonly constructed ICEB walls. The three walls tested in this research include an 1800 mm tall and 900 mm wide slender wall (W4), an 1800mm x 1800mm square wall with a 750 mm wide flange on one end (W5), and a 1800 mm square wall with a 900 mm x 900 mm square opening in the middle (W6). Each wall was constructed from fully grouted ICEBs made on the Cal Poly campus from native soil, sand, and Portland cement. All three walls were tested under displacement controlled cyclic loading. Various instruments were used to capture the shear,

bending, rocking, and sliding displacement components for a better understanding of in-plane performance of ICEB shear walls. Two types of analyses were conducted for calculating the ultimate strength of flexure dominant ICEB walls based on the data collected from shear wall testing: a nonlinear static analysis model assuming lumped plasticity and a plastic analysis model. In addition, incremental dynamic analysis was conducted to address the seismic performance of flexure dominant ICEB buildings. Last, based on the database from the incremental dynamic analysis, the collapse potential of demonstration ICEB buildings were compared for the countries of interest.

Future scope

- Further investigation of the strengths of lintel is necessary to determine the most effective and efficient manner for designing wall with opening.
- Investigation into the bond strength between reinforcement and grout, and between grout and ICEB would provide better insight into the required length necessary to develop required bond strength.

References:

- 1) Mellbom, A, and Pearson, T.(2009). "Interlocking Compressed Earth Blocks: From Soil to Structure." Senior Project, Cal Poly San Luis Obispo, California.
- 2) Bei, G., & Papayianni, I., (2003). "Compressive Strength of Compressed Earth Block Masonry." *Structural Studies, Repairs and Maintenance of Heritage Architecture VIII*, 15, 367-375.
- 3) Bland, D.W. (2011). "In-Plane Cyclic Performance of Interlocking Compressed Earth Block Shear Walls." Masters Thesis. Cal Poly San Luis Obispo, California
- 4) Cheah, J.S, Morgan, (2008). "Cyclic Testing of a Full-Size Stabilized, Flax-Fibre Reinforced Earth (uku) Wall System with Openings". *Proceedings of the 14th world conference on earthquake engineering Beijing*:
- 5) Elshafie, H, Hamid, A, & Nasr, E. (2002). "Strength and Stiffness of Masonry Shear Walls with Openings". *The Masonry Society journal*, 20(1), 49-60.